

GIO42

_REV1.4

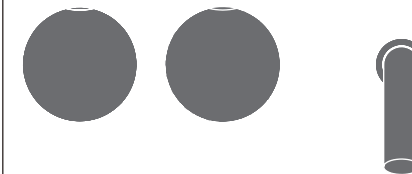

GIO42/GIOTTO

AISI 316L STAINLESS STEEL

Miscelatore bicomando a parete con bocca di erogazione

Wall mounted dual handle mixer with spout

DESIGN
NATALINO MALASORTI





 Portata aeratore 5 l/min / 1.3 gpm, risparmio idrico
Flow rate aerator 5 l/min / 1.3 gpm, water saving

 Possibilità di installazione a 180°
Installation possibility at 180°

 Prodotto che necessita di parte incasso
Product that needs built-in part

 Staffa ausiliaria per cartongesso / fibrogesso
Auxiliary bracket for plasterboard / fiber-board structures

MANUTENZIONE / MAINTENANCE

NON UTILIZZARE DO NOT USE		acido clorico e muriatico chloric and muriatic acid
		acido fluoridrico hydrofluoric acid
		ipoclorito di sodio chlorine bleach
UTILIZZARE TO USE		detergente a pH neutro neutral pH detergent

Questi disegni sono proprietà di CEADDESIGN SRL s.u. pertanto non potranno essere utilizzati e/o comunicati a terzi, anche in forma parziale, senza preventiva autorizzazione. CEADDESIGN SRL s.u. si riserva il diritto di apportare modifiche ai disegni al fine di migliorare il prodotto.

CEADDESIGN SRL s.u. has the property rights on these drawings, therefore they cannot be used and/or transferred to third party, even in partial form, without any prior authorization. Furthermore CEADDESIGN SRL s.u. reserves the right to apply any change to these drawings in order to upgrade the product.

CEA

ceadesign.it

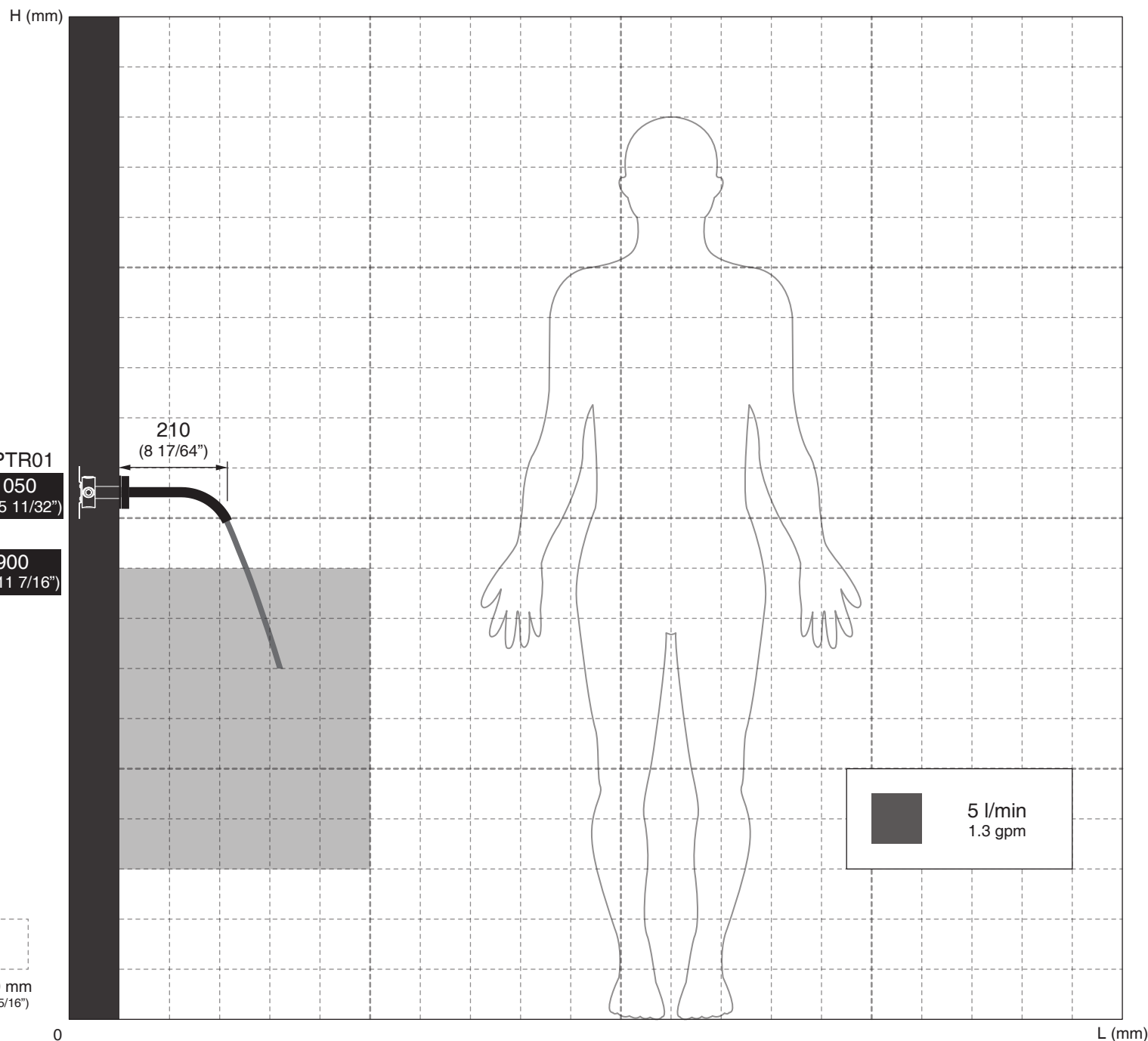

AVVERTENZE DI INSTALLAZIONE

L'altezza ottimale di installazione del prodotto si determina in base all'altezza dell'utente e del lavabo.

La rappresentazione ha valore puramente indicativo.

INSTALLATION WARNINGS

Each individual product has to be installed and adjusted to suit the user's and the washbasin height.

The representation is purely indicative.

INSTALLATIONS WARNUNG

Die optimale Anbringungshöhe der einzelnen Produkte ist abhängig von der Körpergröße der Benutzer und die Waschtisch.

Die Zeichnung ist rein indikativ.

ADVERTENCIAS DE INSTALACIÓN

La altura de colocación ideal de cada producto se determina conforme a la altura de la persona y del lavabo.

La representación es indicativa.

AVERTISSEMENTS D'INSTALLATION

La hauteur optimale de l'emplacement du produit est à déterminer selon la taille de la personne et la hauteur du lavabo.

La représentation est purement indicative.

AERATORE IN DOTAZIONE / AERATOR INCLUDED

 **Aeratore montato / Mounted aerator**
5 l/min / 1.3 gpm

AERATORI SU RICHIESTA / AERATORS ON DEMAND

 Conforme agli standard LEED / Compliant with LEED standards
1,9 l/min / 0,5 gpm

 Conforme agli standard LEED / Compliant with LEED standards
3,8 l/min / 1 gpm

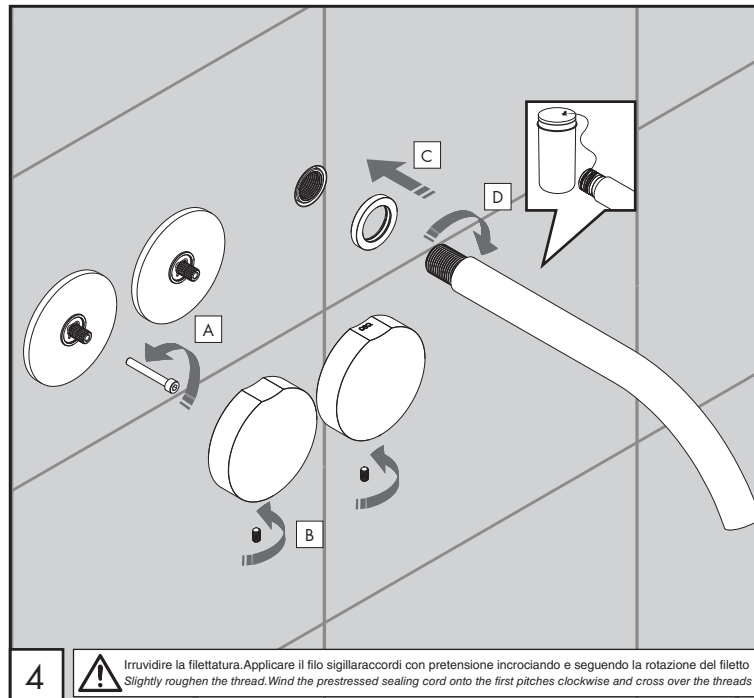
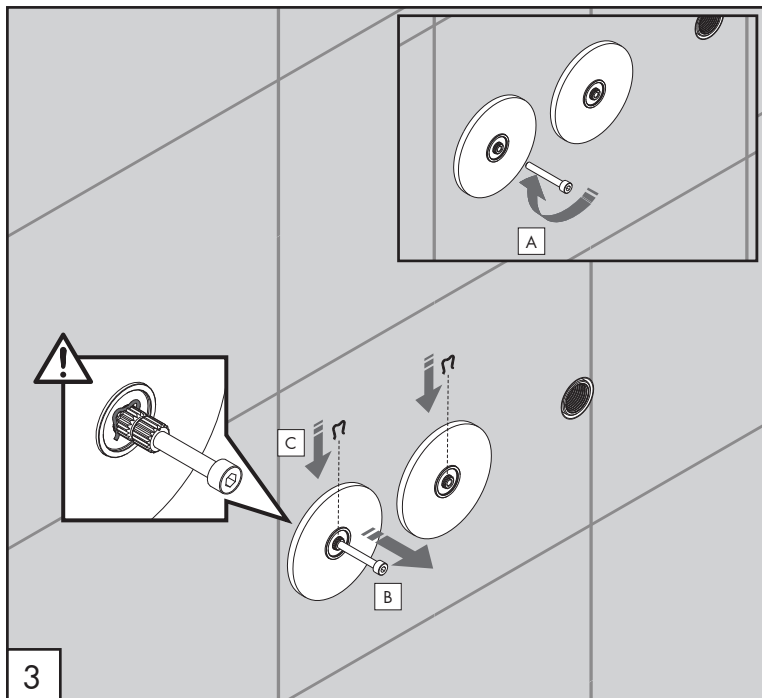
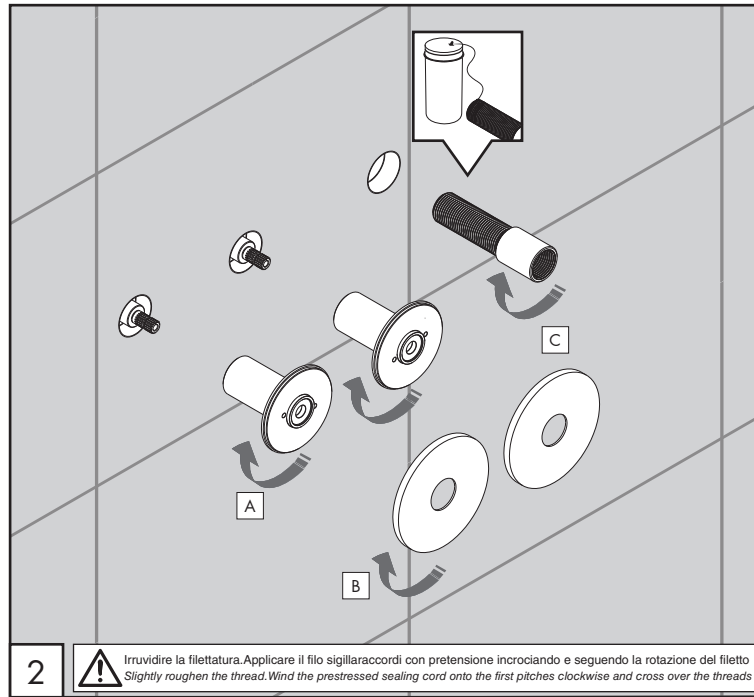
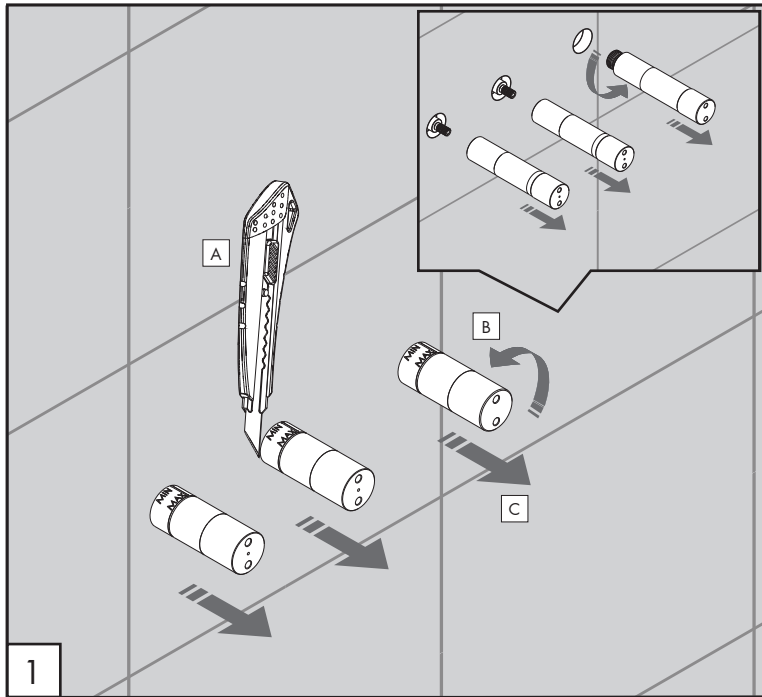

AVVERTENZE TECNICHE

Risciacquare bene le tubazioni prima del montaggio ed evitare sbalzi di pressione fra i raccordi d'acqua fredda e d'acqua calda. In caso di pressioni statiche superiori a 5 bar si raccomanda l'installazione di un riduttore di pressione per evitare danni al vitone.

TECHNICAL WARNINGS

The pipes have to be rinsed thoroughly before installation. Avoid pressure differences between hot and cold water supply. Use of a pressure reducer when static pressure is higher than 5 bar to avoid damage of the shut-off valve.

TECHNISCHE WARNUNG

Spülen Sie die Leitungen vor dem Einbau und verhindern Sie Wasserdruckwechsel zwischen kalt und warm Wasserverbindungen. Wenn Wasserdruck größer als 5 bar ist, bitte reduzieren Sie den Systemdruck, um Beschädigung der Ventil zu verhindern.

ADVERTENCIA TÉCNICA

Los tubos tienen que ser enjuagados a fondo antes de la instalación. Evitar grandes diferencias de presión entre las conexiones de agua caliente y fría. En caso de presión estática mayor de 5 bar, se recomienda el uso de un adaptador de presión para evitar daños en la válvula.

ADVERTISSEMENTS TECHNIQUES

Rincer les tuyaux avant l'installation. Eviter des grandes différences de pression entre l'eau froide et chaude. En cas de pressions statique de plus de 5 bar, nous vous recommandons d'installer un réducteur de pression pour éviter des dommages à la vanne d'ouverture/d'arrêt.

TEMPERATURA DI ESERCIZIO / WORKING TEMPERATURE

max. 65 °C
 max. 149 °F

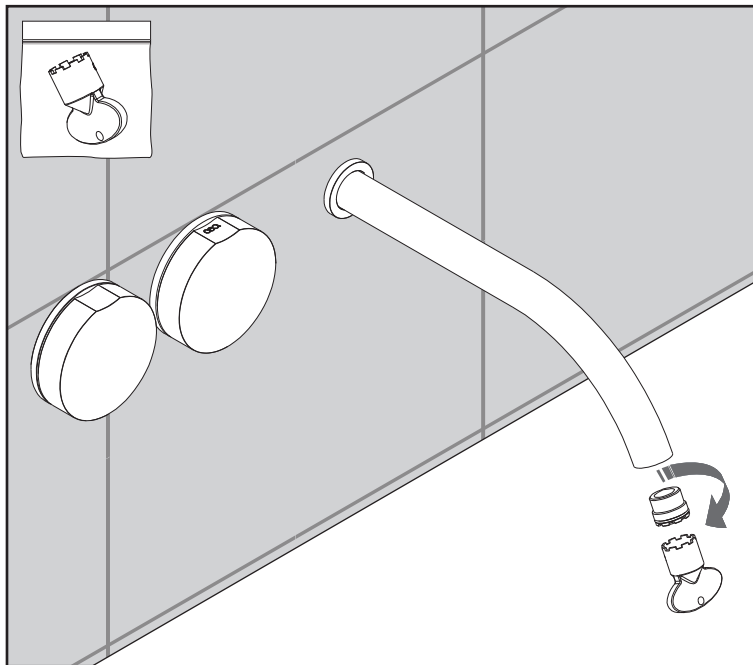
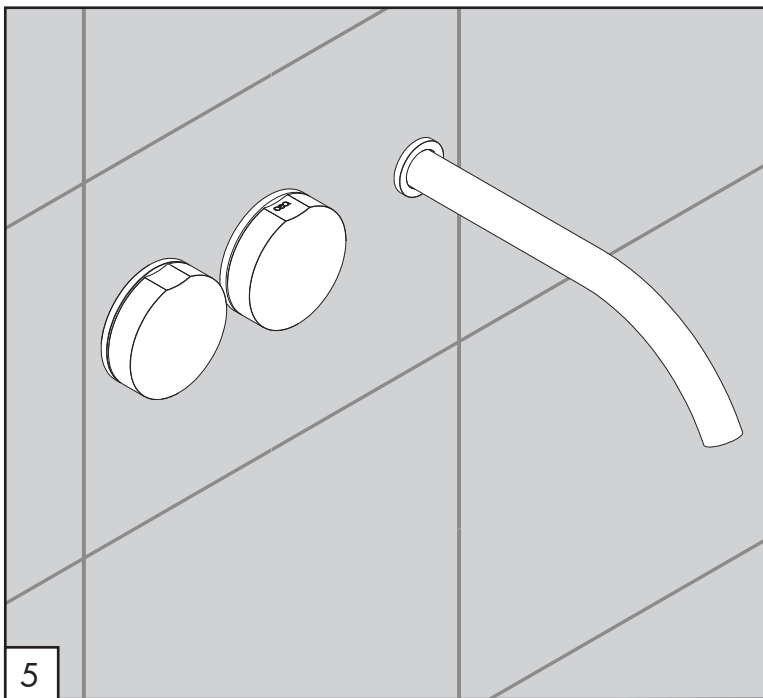

RICAMBI / SPARE PARTS

RICB049	Carter / Carter
RICM108	Maniglia / Handle
RICM111	Maniglia / Handle
RICM118	Maniglia / Handle
RICR073	Rosetta / Rosette

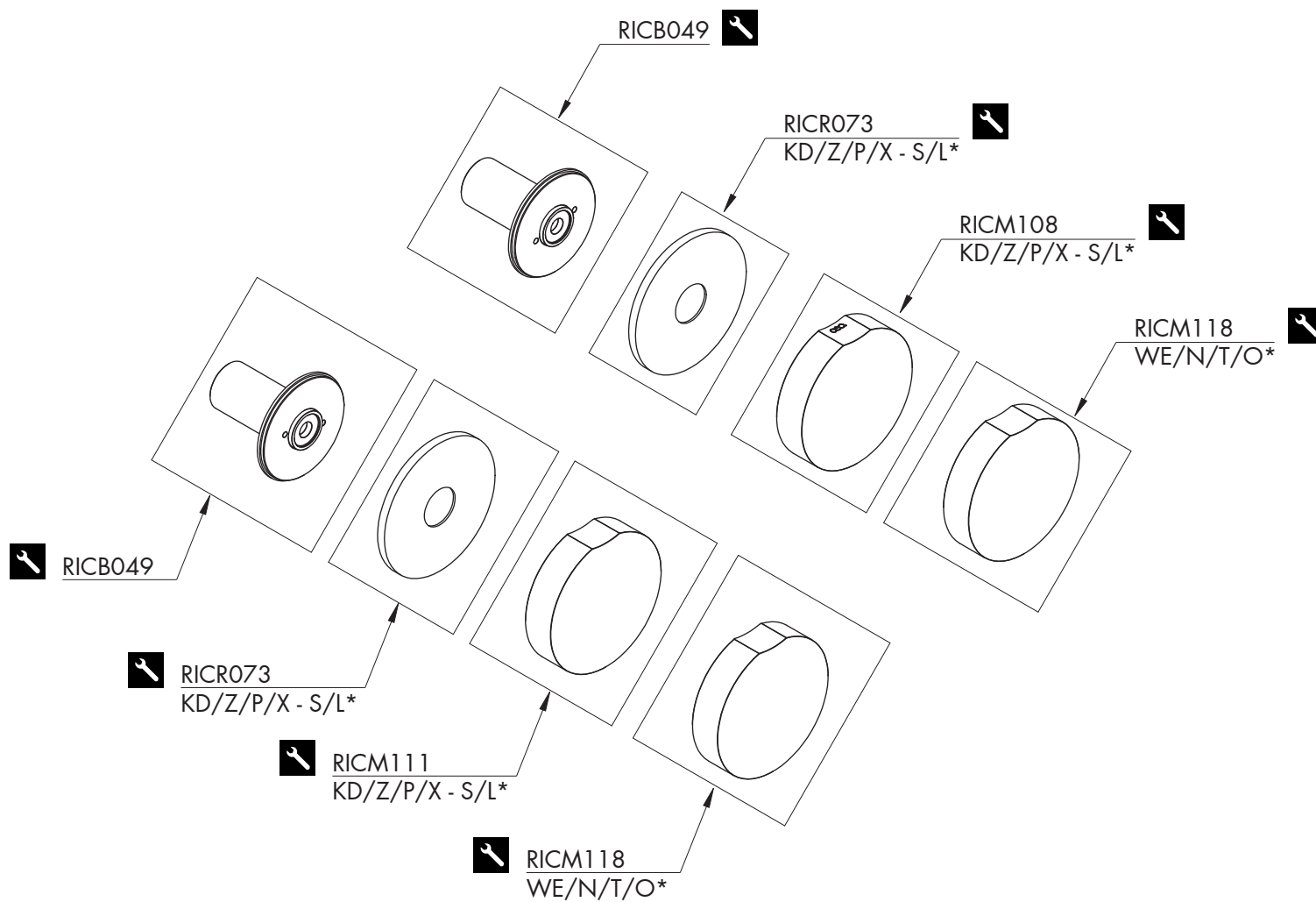

! Conservare gli strumenti inclusi nel prodotto e utilizzati per l'installazione perchè riutilizzabili per i ricambi.

Please, keep the tools included in the item pack and employed for its installation, to re-used them for the spare parts.

Die im Produkt enthaltenen Werkzeuge aufbewahren, da sie für die Ersatzteile wiederverwendet werden können.

No tirar las herramientas incluidas en el producto y usadas durante la instalación puesto que se pueden reutilizar para los recambios.

Veillez conserver les outils inclus dans la boîte du produit et employés pour son installation, parce que réutilisables pour les pièces de rechange.

LEGENDA / LEGEND

ICONE / ICONS

 Utensile incluso nel ricambio
Tool included in spare part

FINITURE / FINISHES

*S finitura satinata / satin finish
L finitura lucidata / polished finish

FINITURE SPECIALI / SPECIAL FINISHES

KD black diamond
Z bronzo / bronze
P rame / copper
X light gold

ESSENZE LEGNO / WOOD ESSENCES

*WE wengé / wenge
N noce canaletto / canaletto walnut
T teak birmano / burma teak
O rovere / oak

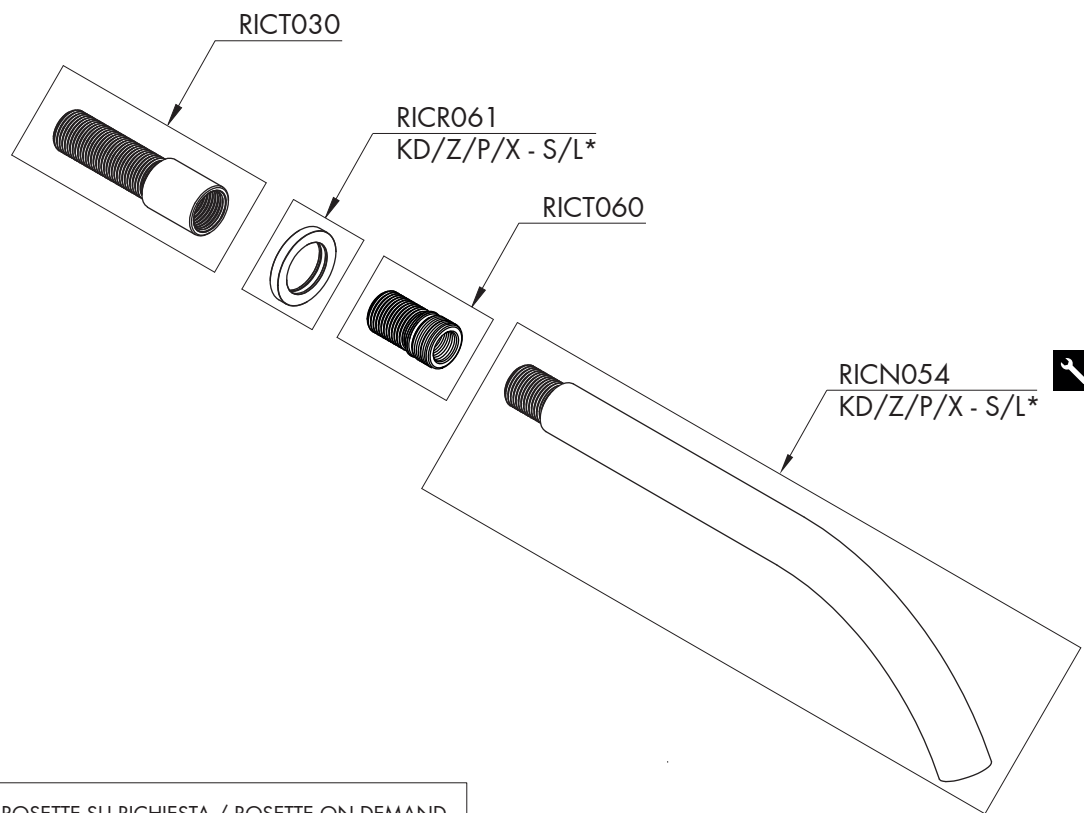

ROSETTE SU RICHIESTA / ROSETTE ON DEMAND

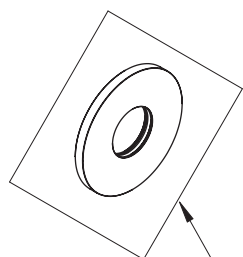

RICR139
KD/Z/P/X - S/L*

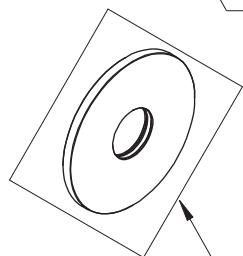

RICR132
KD/Z/P/X - S/L*

AERATORE IN DOTAZIONE / AERATOR INCLUDED



RICA001

AERATORI SU RICHIESTA / AERATORS ON DEMAND



RICA055



RICA056

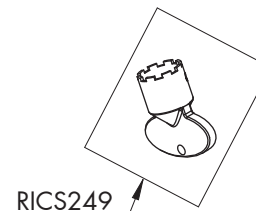

RICS249

RICAMBI / SPARE PARTS

RICA001	Aeratore / Aerator	5 l/min / 1.3 gpm
RICN054	Bocca di erogazione / Spout	
RICR061	Rosetta / Rosette	
RICS249	Chiave aeratore / Key for aerator	
RICT030	Raccordo / Fitting	
RICT060	Raccordo / Fitting	

AERATORI SU RICHIESTA / AERATORS ON DEMAND

RICA055	Aeratore / Aerator	1,9 l/min / 0.5 gpm
RICA056	Aeratore / Aerator	3,8 l/min / 1 gpm

ROSETTE SU RICHIESTA / ROSETTE ON DEMAND

RICR132	Rosetta Ø esterno 65 mm Rosette external Ø 65 mm
RICR139	Rosetta Ø esterno 52 mm Rosette external Ø 52 mm

LEGENDA / LEGEND

ICONE / ICONS

- Aeratore a risparmio idrico, utilizzabile per lavabo
Water saving aerator, suitable for washbasin
- Utensile incluso nel ricambio
Tool included in spare part

FINITURE / FINISHES

- *S finitura satinata / satin finish
- L finitura lucidata / polished finish

FINITURE SPECIALI / SPECIAL FINISHES

- KD black diamond
- Z bronzo / bronze
- P rame / copper
- X light gold