

A

B

C

D

6

6

5

5

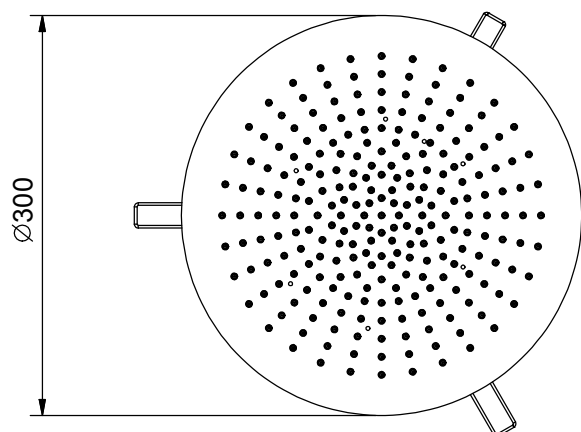

4

4

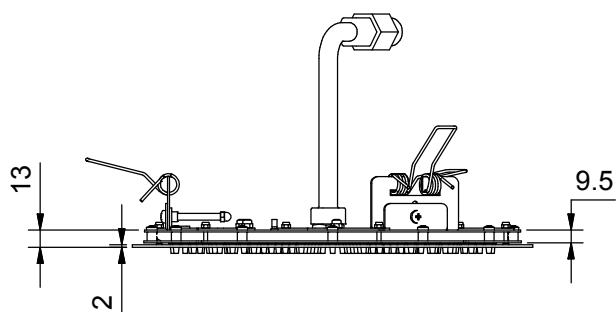

3

3

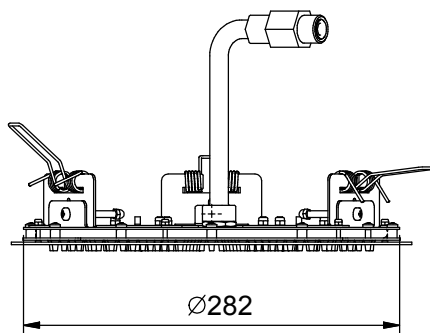

2

2

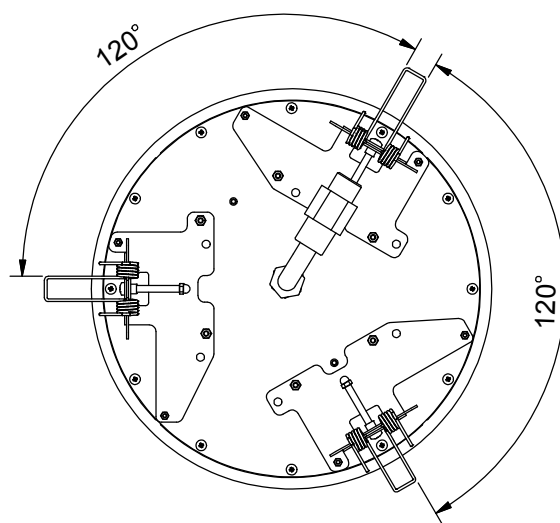

Art.: K072

Serie: ACQUAFIT TONDO



Desc.:

IT- SOFFIONE MULTIFUNZIONE
 EN- CEILING MOUNT MULTIFUNCTION SHOWERHEAD
 DE- MULTIFUNKTIONSKOPFBRAUSE
 FR- POMME DE DOUCHE MULTIFONCTION
 ES- ROCIADOR MULTIFUNCIO'N

Data:

Rev.:

Disegnato:

Approvato: ...

Questo disegno e' di proprieta' della FANTINI S.p.A. Pertanto non potra' essere utilizzato e/o comunicato a terzi, anche in forma parziale, senza preventiva autorizzazione.
 This drawing is intellectual of FANTINI S.p.A. No use or disclosure, either fully or partially, to third parties is allowed whitout prior consent of the company.

A

B

C

D

1

1