

GIO24

_REV1.4



DESIGN
NATALINO MALASORTI



GIO24/GIOTTO
AISI 316/L STAINLESS STEEL

Gruppo miscelatore idroprogressivo
vasca/doccia con doccia

*Hydroprogressive mixer set
for bath/shower with hand shower*



PRODOTTI CORRELATI / RELATED PRODUCTS

FRE74 - MIL91



Possibilità di installazione a 180°
Installation possibility at 180°



Prodotto che necessita di parte incasso
Product that needs built-in part



Staffa ausiliaria per cartongesso / fibrogesso
Auxiliary bracket for plasterboard / fiber-board structures

MANUTENZIONE / MAINTENANCE

NON UTILIZZARE
DO NOT USE



acido clorico e muriatico
chloric and muriatic acid



acido fluoridrico
hydrofluoric acid



ipoclorito di sodio
chlorine bleach

UTILIZZARE
TO USE



sapone a PH neutro
neutral PH soap

Questi disegni sono proprietà di CEADDESIGN SRL s.u. pertanto non potranno essere utilizzati e/o comunicati a terzi, anche in forma parziale, senza preventiva autorizzazione. CEADDESIGN SRL s.u. si riserva il diritto di apportare modifiche ai disegni al fine di migliorare il prodotto.

CEADDESIGN SRL s.u. has the property rights on these drawings, therefore they cannot be used and/or transferred to third party, even in partial form, without any prior authorization. Furthermore CEADDESIGN SRL s.u. reserves the right to apply any change to these drawings in order to upgrade the product.

CEA

ceadesign.it

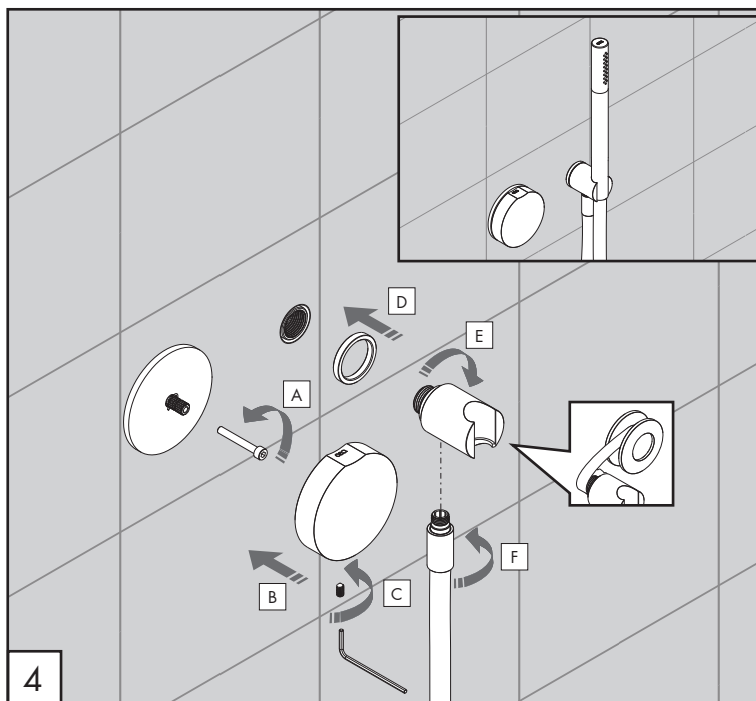
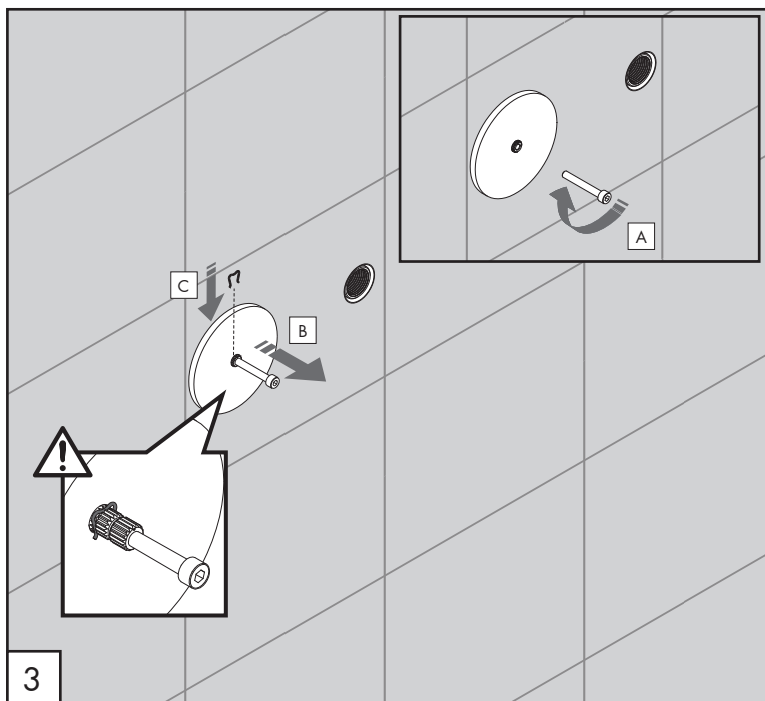
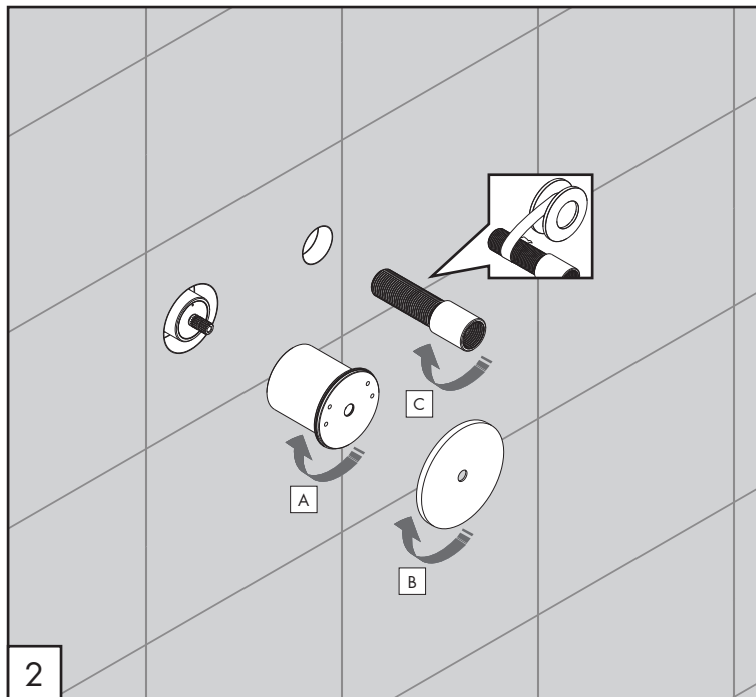
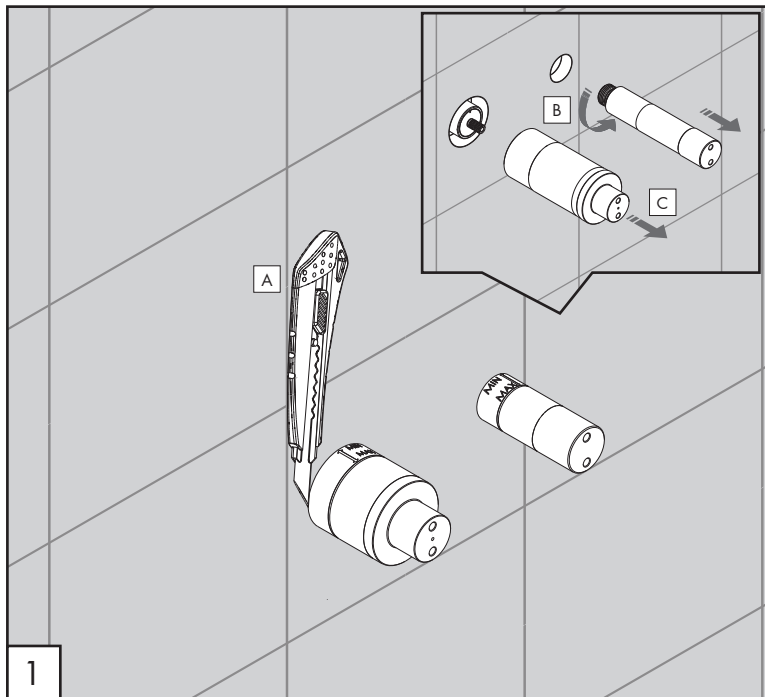

AVVERTENZE TECNICHE

Risciacquare bene le tubazioni prima del montaggio ed evitare sbalzi di pressione fra i raccordi d'acqua fredda e d'acqua calda. In caso di pressioni statiche superiori a 5 bar si raccomanda l'installazione di un riduttore di pressione per evitare danni alla cartuccia.

TECHNICAL WARNINGS

The pipes have to be rinsed thoroughly before installation. Avoid pressure differences between hot and cold water supply. Use of a pressure reducer when static pressure is higher than 5 bar to avoid damage of the cartridge.

TECHNISCHE WARNUNG

Spülen Sie die Leitungen vor dem Einbau und verhindern Sie Wasserdruckwechsel zwischen kalt und warm Wasserverbindungen. Wenn Wasserdruck größer als 5 bar ist, bitte reduzieren Sie den Systemdruck, um Beschädigung der Kartusche zu verhindern.

ADVERTENCIA TÉCNICA

Los tubos tienen que ser enjuagados a fondo antes de la instalación. Evitar grandes diferencias de presión entre las conexiones de agua caliente y fría. En caso de presión estática mayor de 5 bar, se recomienda el uso de un adaptador de presión para evitar daños en el cartucho.

ADVERTISSEMENTS TECHNIQUES

Rincer les tuyaux avant l'installation. Eviter des grandes différences de pression entre l'eau froide et chaude. En cas de pressions statique de plus de 5 bar, nous vous recommandons d'installer un réducteur de pression pour éviter des dommages à la cartouche.

PORTATE / FLOW RATE

BAR	uscita doccia / hand shower outlet			
	acciaio inox / stainless steel l/min	gal/min	gomma siliconica / silicone rubber l/min	gal/min
1	8,5	2,2	6,7	1,8
2	12,3	3,2	9,8	2,6
3*	15,1	4,0	11,4	3,0
4	17,5	4,6	12,8	3,4
5	19,7	5,2	14,1	3,7

* Pressione consigliata
Recommended pressure

max. 70 °C
max. 158 °F

COMPONENTI / PARTI DI RICAMBIO
COMPONENTS / SPARE PARTS

RICB045	Carter / Carter
RICM108	Maniglia / Handle
RICM118	Maniglia / Handle
RICR039	Rosetta / Rosette
RICR070	Rosetta / Rosette
RICT030	Tappo/Raccordo / Plug/Fitting
RICU001	Supporto doccia / Hand shower holder

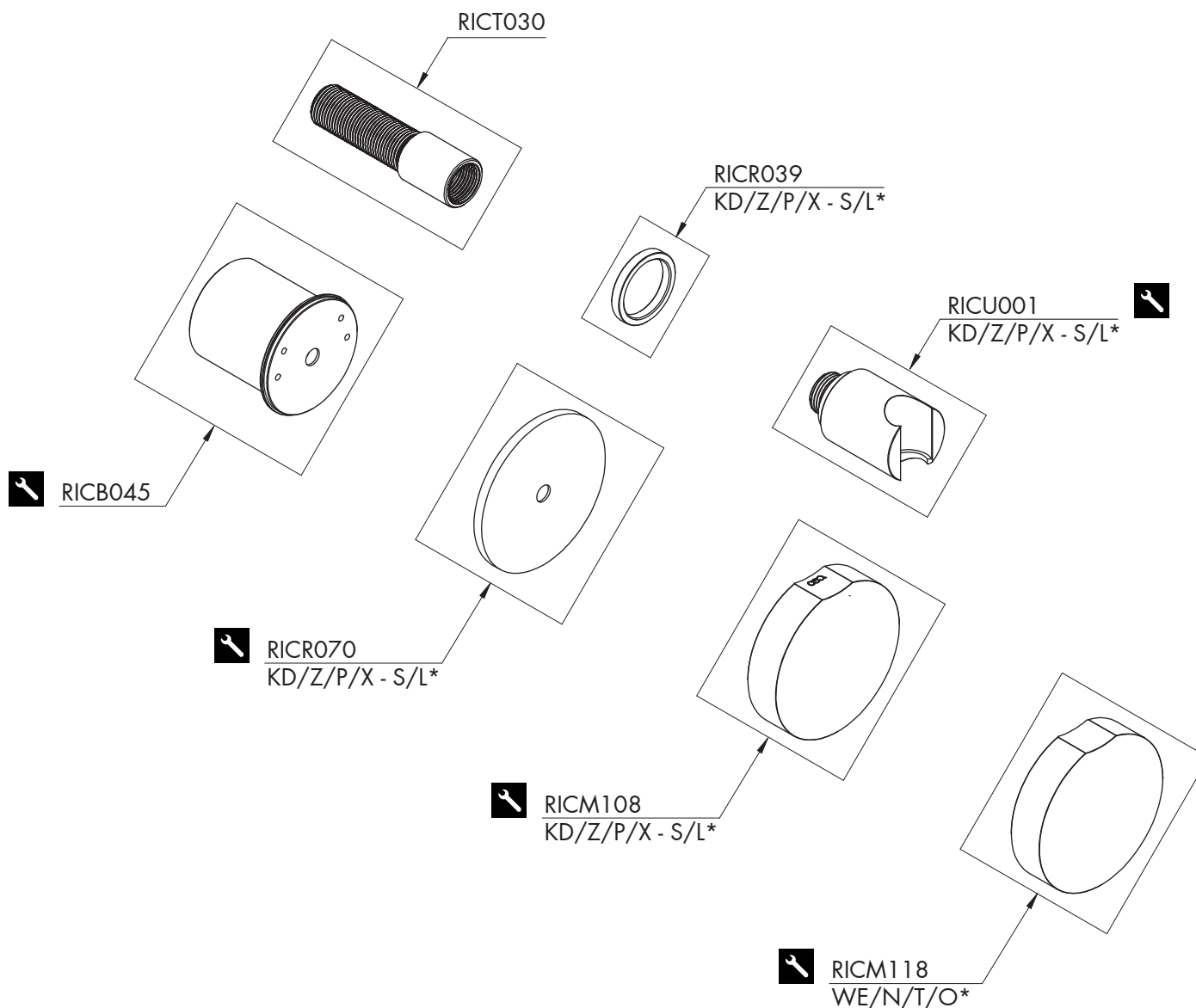

LEGENDA / LEGEND

ICONE / ICONS

 utensili inclusi nel ricambio
tools included in spare parts

FINITURE / FINISHES

*S finitura satinata / satin finish
L finitura lucidata / polished finish

FINITURE SPECIALI / SPECIAL FINISHES

KD black diamond
Z bronzo / bronze
P rame / copper
X light gold

ESSENZE LEGNO / WOOD ESSENCES

*WE wengè / wenge
N noce americano / american walnut
T teak birmano / burma teak
O rovere / oak

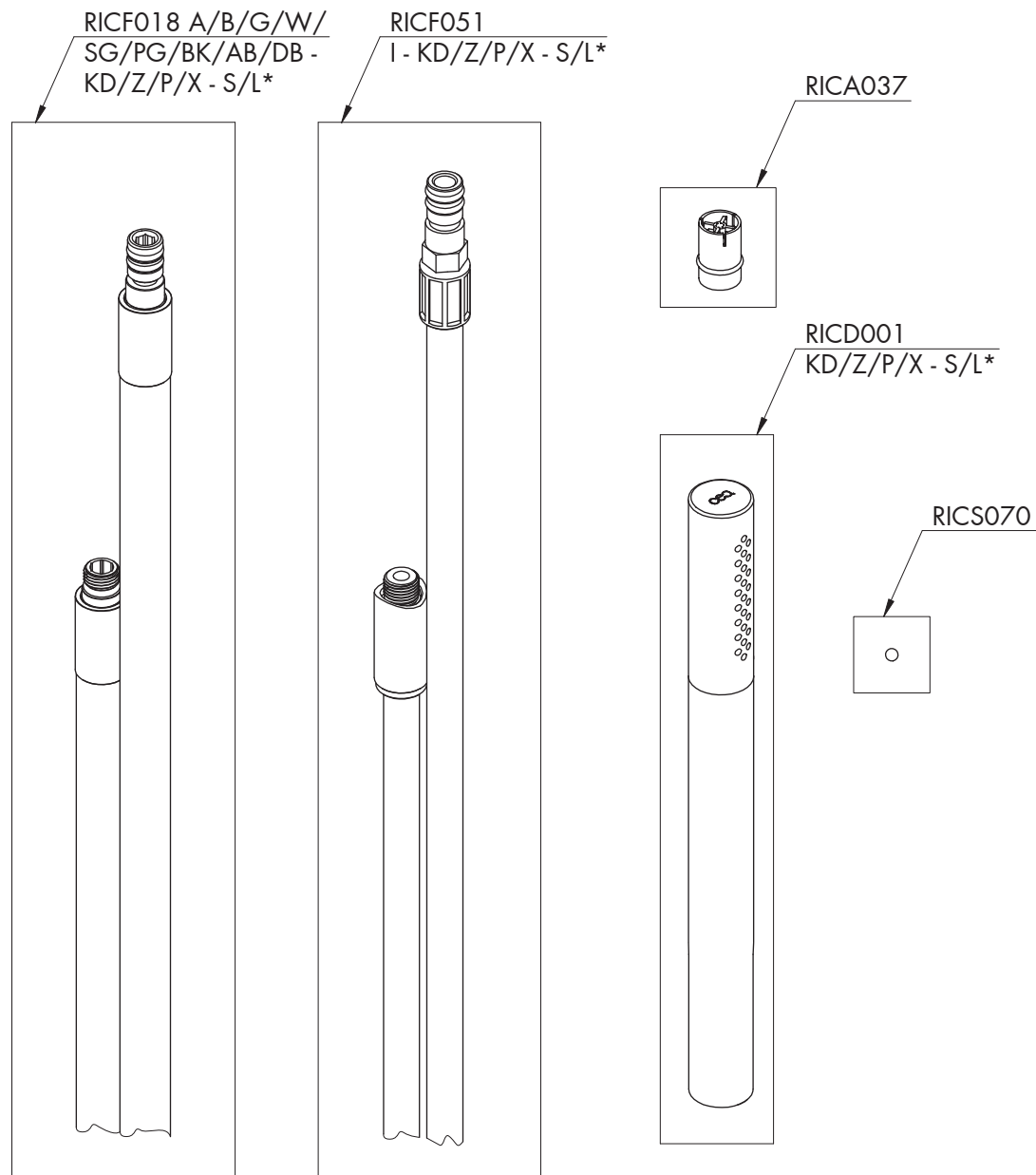

COMPONENTI / PARTI DI RICAMBIO COMPONENTS / SPARE PARTS

RICA037	Valvola di non ritorno / <i>Check valve</i>
RICD001	Doccino / <i>Hand shower</i>
RICF018	Flessibile / <i>Hose</i>
RICF051	Flessibile / <i>Hose</i>
RICS070	Sacchetto / <i>Bag</i>

LEGENDA / LEGEND

ICONE / ICONS

 utensili inclusi nel ricambio
tools included in spare parts

FINITURE / FINISHES

*S finitura satinata / *satin finish*
L finitura lucidata / *polished finish*

FINITURE SPECIALI / SPECIAL FINISHES

KD black diamond
Z bronzo / *bronze*
P rame / *copper*
X light gold

COLORI FLESSIBILE / HOSE COLOURS

A	verde acqua / <i>aqua green</i>	RAL 6027
B	blu cobalto / <i>cobalt blue</i>	RAL 5013
G	grigio antracite / <i>anthracite grey</i>	RAL 7043
W	bianco / <i>white</i>	RAL 9016
SG	grigio seta / <i>silk grey</i>	RAL 7044
PG	verde petrolio / <i>petroleum green</i>	RAL 5020
BK	nero / <i>black</i>	RAL 9004
AB	blu avio / <i>air force blue</i>	RAL 5014
DB	grigio quarzo / <i>quartz grey</i>	RAL 7039
I	acciaio inox / <i>stainless steel</i>	